

SUPPORTI PER CARICHI ELEVATI

AMC MECANOCAUCHO® ANTISCIVOLO

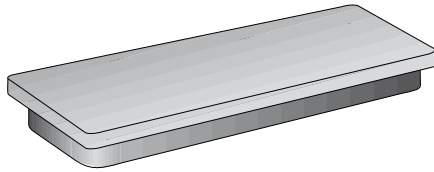

**DUREZZA
141003**

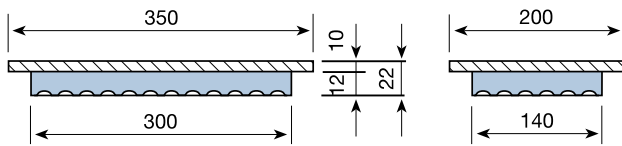

AMC MECANOCAUCHO® TIPO B

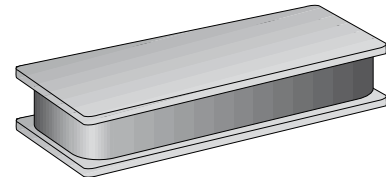

**DUREZZA
141004**

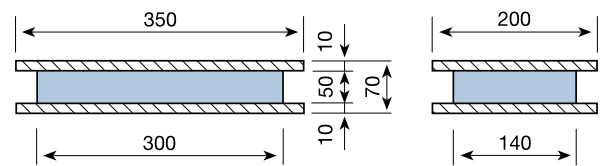

AMC MECANOCAUCHO® TIPO P

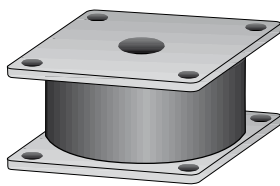

**CODICE
141005**

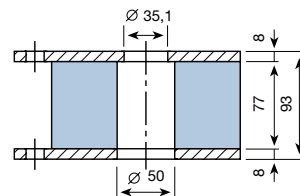
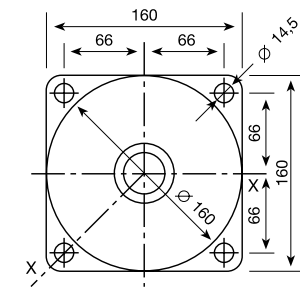

AMC MECANOCAUCHO® TIPO ANTISCIVOLO P

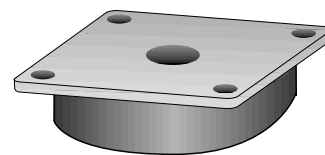

**CODICE
141006**

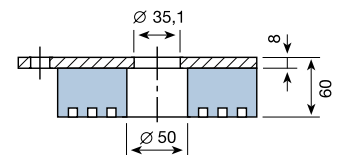
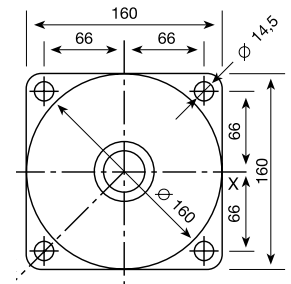

AMC MECANOCAUCHO® TIPO S

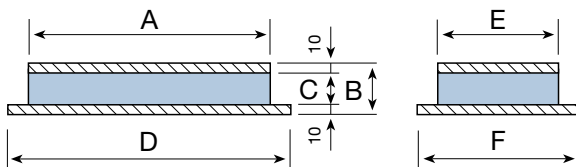

TIPO	CODICE	A	B	C	D	E	F	CARICO Kg.	FLESSIONE mm.
L-40	141021	300	40	20	350	140	200	15.000	5
L-50	141022	300	50	30	350	140	200	13.000	5
L-60	141023	300	60	40	350	140	200	11.000	5
L-70	141024	300	70	50	350	140	200	9.000	5

AMC MECANOCAUCHO® TIPO G.C.

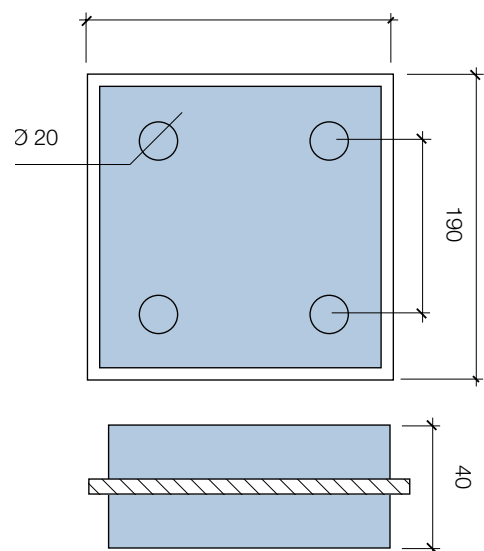

**Carico: 30.000 Kg.
Flessione: 8 mm.**

**CODICE
141041**

SUPPORTI PER GRANDI CARICHI

SUPPORTI PER GRANDI CARICHI DINAMICO

FREQUENZE PROPRIE AMC
MECANOCAUCHO® TIPO S.G. CARICHI

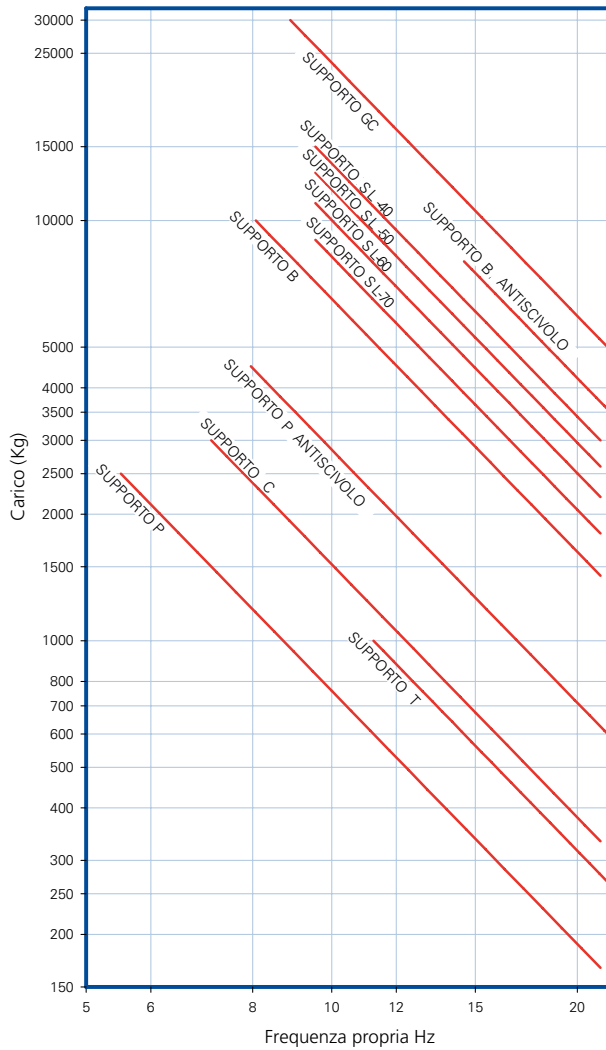

SUPPORTI PER GRANDI CARICHI FLESSIONE

CURVE CARICO FLESSIONE AMC
MECANOCAUCHO® TIPO S.G. CARICHI

